

article#	9215-6t25v
article description	CEE-wall socket + CH T25 COMBO 16A 5p 6h IP54
description long	CEE-wall mounted socket + CH T25 socket COMBO 16A 5p 6h IP54 housing material: PA6 rated current: 16A number of poles: 5 (3P+N+PE) clock-position: 6h rated voltage/frequency: 200/346V~ - 240/415V~ / 50+60Hz contacts: brass nickel plated connection technology: screw terminals cable entry: top, 2x bottom, rear with safety socket CH-system T25 (IP55) - ready wired IP protection class: IP54
GTIN (EAN)	9003399611773
country of origin	AT
customs number	85366990
net weight	0.491 kg
packaging quantity	5
minimum order quantity	5

ETIM 9.0	EC000379
CEE socket outlet 16 A	1x16A5p400V
number of socket outlets swiss standard type 25	1
Material housing	Plastic
Contact material	CuZn
Surface treatment contacts	Nickel-plated
Power supply/connection possibility	2 cables (ring line)
Handling	Wall mounting
Degree of protection (IP)	IP54
Colour	Grey

a	176 mm
b	133 mm
wire flexible	1-2,5 mm ²
wire solid	1-4 mm ²
contact screws	110 Ncm
housing screws	110 Ncm
connecting screws	110 Ncm
dismantling length	50 mm
stripping length	12-14 mm

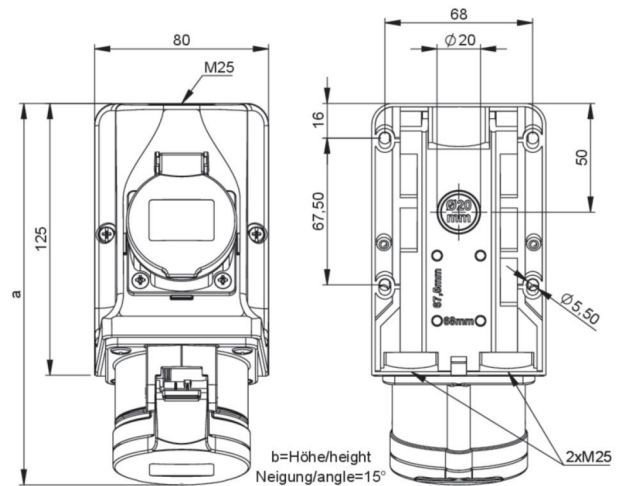

<https://www.pcelectric.at/shop/en/?func=detail&artnr=9215-6t25v>