

article#	77734-1k
article description	CEE-flanged plug compact 63A 4p 1h IP67 POWER TWIST
description long	CEE-flanged plug compact 63A 4p 1h IP67 POWER TWIST housing material: PA6 rated current: 63A number of poles: 4 (3P+PE) clock-position: 1h rated voltage/frequency: >50V / others contacts: brass nickel plated, with pilot pin connection technology: frame terminals with screws IP protection class: IP66/IP67
country of origin	AT
customs number	85366990
packaging quantity	2
minimum order quantity	2

ETIM 9.0	EC001319
IEC-amperage	63 A
Voltage according to EN 60309-2	Other
Number of poles	4
Clock hour position	1 h
Identification colour	Grey
Degree of protection (IP)	IP67
Connection system	Screwed terminal
Construction type	Built-up device plug
Phase inverter	False
Angle of plug	Angled
Material	Plastic
Contact material	CuZn
Surface treatment contacts	Nickel-plated

a	116 mm
b	91 mm
c	95 mm
d	70 mm
e	132 mm
f	181 mm
g	70 mm
h	70 mm
i	6,5 mm
wire flexible	6-16 mm ²
wire solid	6-25 mm ²
contact screws	200 Ncm
connecting screws	200 Ncm
dismantling length	100 mm
stripping length	15-18 mm
ambient temperature	-25 – 40 °C
temperature resistance	-25 – 80 °C

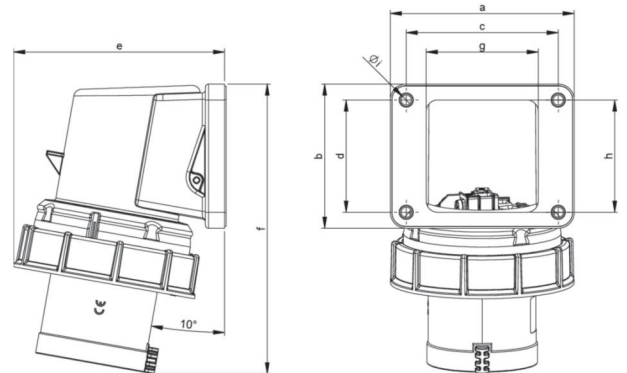

<https://www.pcelectric.at/shop/en/?func=detail&artnr=77734-1k>