

article#	777132-1v
article description	CEE-flanged plug angled 16A 3p 1h IP67
description long	CEE-flanged plug angled 16A 3p 1h IP67 housing material: PC/ABS rated current: 16A number of poles: 3 (2P+PE) clock-position: 1h rated voltage/frequency: >50V / others contacts: brass nickel plated connection technology: screw terminals IP protection class: IP67
country of origin	AT
customs number	85366990
packaging quantity	10
minimum order quantity	10

ETIM 9.0	EC001319
IEC-amperage	16 A
Voltage according to EN 60309-2	Other
Number of poles	3
Clock hour position	1 h
Identification colour	Grey
Degree of protection (IP)	IP67
Connection system	Screwed terminal
Construction type	Built-up device plug
Angle of plug	Angled
Material	Plastic
Contact material	CuZn
Surface treatment contacts	Nickel-plated

a	66 mm
b	86 mm
c	53 mm
d	61 mm
e	116 mm
f	99 mm
g	5 mm
wire flexible	1-2,5 mm ²
wire solid	1-4 mm ²
contact screws	100 Ncm
dismantling length	50 mm
stripping length	10-12 mm
ambient temperature	-25 – 40 °C
temperature resistance	-25 – 80 °C

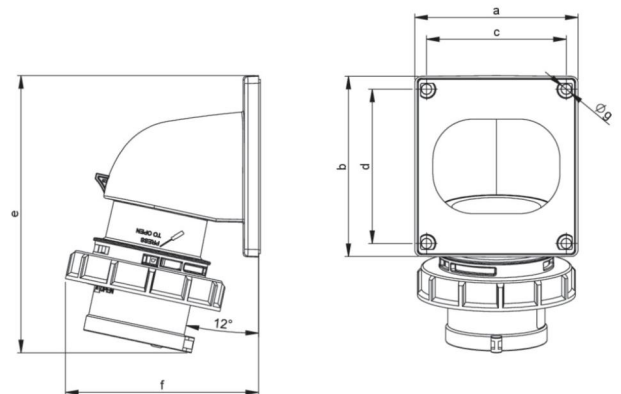

<https://www.pcelectric.at/shop/en/?func=detail&artnr=777132-1v>