

article#	614-1f3
article description	CEE-flanged plug 56x56 straight 16A 4p 1h IP44
description long	CEE-flanged plug 56x56 straight 16A 4p 1h IP44 housing material: PA6 rated current: 16A number of poles: 4 (3P+PE) clock-position: 1h rated voltage/frequency: >50V / others contacts: brass connection technology: screw terminals dimensions (flange/fixing center): 56x56 mm / 48x48 mm IP protection class: IP44
country of origin	AT
customs number	85366990
packaging quantity	10
minimum order quantity	10

ETIM 9.0	EC001319
IEC-amperage	16 A
Voltage according to EN 60309-2	Other
Number of poles	4
Clock hour position	1 h
Identification colour	Grey
Degree of protection (IP)	IP44
Connection system	Screwed terminal
Construction type	Built-up device plug
Angle of plug	Straight
Material	Plastic
Contact material	CuZn
Surface treatment contacts	Untreated

a	56 mm
b	56 mm
c	48 mm
d	48 mm
e	21 mm
f	42 mm
g	4,5 mm
h	43 mm
wire flexible	1-2,5 mm ²
wire solid	1-4 mm ²
contact screws	100 Ncm
dismantling length	50 mm
stripping length	10-12 mm
ambient temperature	-25 – 40 °C
temperature resistance	-25 – 80 °C

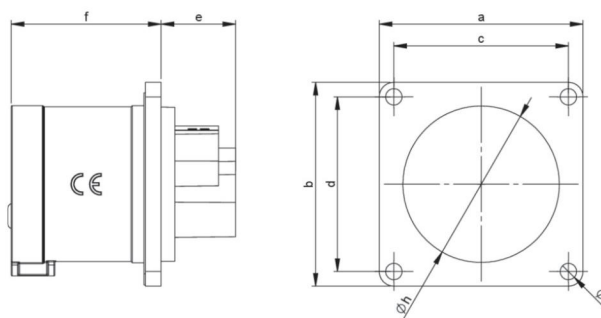





<https://www.pcelectric.at/shop/en/?func=detail&artnr=614-1f3>