

article#	<b>2249-6</b>
article description	<b>CEE-connector 30A 3P4W 6h IP44 UL</b>
description long	CEE-connector 30A 3P4W 6h IP44 UL (PCE430C6S) housing material: PA6 rated current: 32A/30A number of poles: 3P4W (4p) clock position: 6h rated voltage: 380Vac contacts: brass connection technology: screw terminals IP protection class: IP44 according to UL1682 und IEC/EN 60309-2 (SERIE II) UL-product category: QLHN / QLHN7 UL-file number: E232901
GTIN (EAN)	9003399143953
country of origin	AT
customs number	85366990
net weight	0.244 kg
packaging quantity	10
minimum order quantity	10

ETIM 9.0	EC001320
IEC-amperage	32 A
Amperage according to UL/CSA (for UL-version)	30 A
Number of poles	4
Clock hour position	6 h
Identification colour	Red
Degree of protection (IP)	IP44
Connection system	Screwed terminal
Angle of plug	Straight
Cable entry	Gland nut
Material	Plastic
Contact material	CuZn
Surface treatment contacts	Untreated

a	6.34 inch
b	3.70 inch
K (cable Ø)	0.52-0.76 inch
SW	1.97 inch
wire flexible	14-10 AWG
contact screws	9.74 lbf-in
strain relief	62.0 lbf-in
dismantling length	1.97 inch
stripping length	0.47-0.55 inch
temperature resistance	-13 – 176 °F

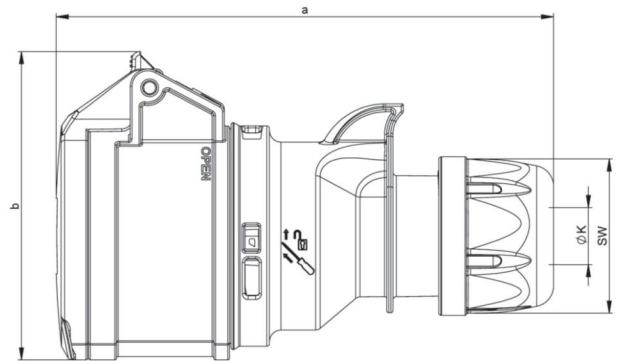

<https://www.pcelectric.at/shop/en/?func=detail&artnr=2249-6>