

article#	224-1
article description	CEE-connector 32A 4p 1h IP44 SHARK
description long	CEE-connector 32A 4p 1h IP44 SHARK housing material: PA6 rated current: 32A number of poles: 4 (3P+PE) clock-position: 1h rated voltage/frequency: >50V / others contacts: brass connection technology: screw terminals IP protection class: IP44
GTIN (EAN)	9003399110214
country of origin	AT
customs number	85366990
net weight	0.244 kg
packaging quantity	10
minimum order quantity	10

ETIM 9.0	EC001320
IEC-ampereage	32 A
Number of poles	4
Voltage according to EN 60309-2	Other
Clock hour position	1 h
Identification colour	Grey
Degree of protection (IP)	IP44
Connection system	Screwed terminal
Angle of plug	Straight
Cable entry	Gland nut
Material	Plastic
Contact material	CuZn
Surface treatment contacts	Untreated

a	161 mm
b	94 mm
K (cable Ø)	11,5-20 mm
SW	50 mm
wire flexible	2,5-6 mm ²
contact screws	110 Ncm
strain relief	600 Ncm
dismantling length	50 mm
stripping length	12-14 mm
ambient temperature	-25 – 40 °C
temperature resistance	-25 – 80 °C

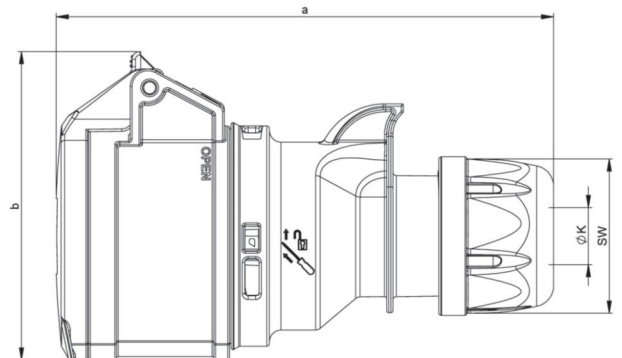

<https://www.pcelectric.at/shop/en/?func=detail&artnr=224-1>