

article#	<b>2239-5v</b>
article description	<b>CEE-connector 30A 2P3W 5h IP44 UL</b>
description long	CEE-connector 30A 2P3W 5h IP44 UL (PCE330C5Sv) housing material: PA6 rated current: 30A number of poles: 2P3W (3p) clock position: 5h rated voltage: 277Vac contacts: brass nickel plated connection technology: screw terminals IP protection class: IP44 according to UL1682 UL-product category: QLHN / QLHN7 UL-file number: E232901
country of origin	AT
customs number	85366990
packaging quantity	10
minimum order quantity	10

ETIM 9.0	EC001320
Amperage according to UL/CSA (for UL-version)	30 A
Number of poles	3
Clock hour position	5 h
Identification colour	Grey
Degree of protection (IP)	IP44
Connection system	Screwed terminal
Angle of plug	Straight
Cable entry	Gland nut
Material	Plastic
Contact material	CuZn
Surface treatment contacts	Nickel-plated

a	6.34 inch
b	3.70 inch
K (cable Ø)	0.52-0.76 inch
SW	1.97 inch
wire flexible	14-10 AWG
contact screws	9.74 lbf-in
strain relief	62.0 lbf-in
dismantling length	1.97 inch
stripping length	0.47-0.55 inch
temperature resistance	-13 – 176 °F

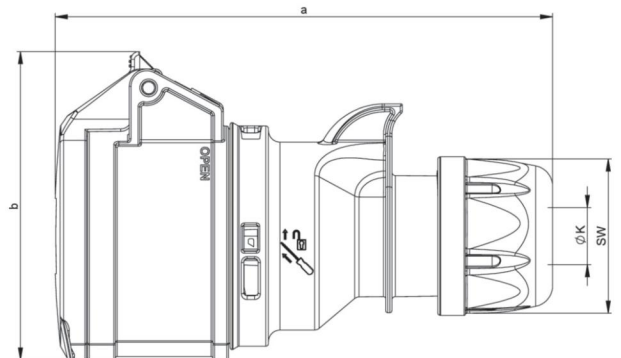

<https://www.pcelectric.at/shop/en/?func=detail&artnr=2239-5v>