

article#	214-2
article description	CEE-connector 16A 4p 2h IP44 SHARK
description long	CEE-connector 16A 4p 2h IP44/IP54 SHARK housing material: PA6 rated current: 16A number of poles: 4 (3P+PE) clock-position: 2h rated voltage/frequency: >50V~ / 300-500Hz contacts: brass connection technology: screw terminals IP protection class: IP44/IP54
GTIN (EAN)	9003399080432
country of origin	AT
customs number	85366990
net weight	0.161 kg
packaging quantity	10
minimum order quantity	10

ETIM 9.0	EC001320
IEC-amperage	16 A
Number of poles	4
Voltage according to EN 60309-2	50-500 V (>300-500 Hz) green
Clock hour position	2 h
Identification colour	Green
Degree of protection (IP)	IP44
Connection system	Screwed terminal
Angle of plug	Straight
Cable entry	Gland nut
Material	Plastic
Contact material	CuZn
Surface treatment contacts	Untreated

a	138 mm
b	82 mm
K (cable Ø)	6-15 mm
SW	42 mm
wire flexible	1-2,5 mm ²
contact screws	100 Ncm
strain relief	500 Ncm
dismantling length	50 mm
stripping length	10-12 mm
ambient temperature	-25 – 40 °C
temperature resistance	-25 – 80 °C

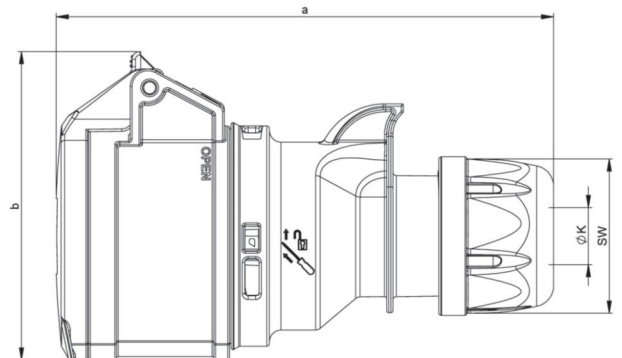

<https://www.pcelectric.at/shop/en/?func=detail&artnr=214-2>