

article#	<b>2139-5</b>
article description	<b>CEE-connector 20A 2P3W 5h IP44 UL</b>
description long	CEE-connector 20A 2P3W 5h IP44 UL (PCE320C5S) housing material: PA6 rated current: 20A number of poles: 2P3W (3p) clock position: 5h rated voltage: 277Vac contacts: brass connection technology: screw terminals IP protection class: IP44 according to UL1682 UL-product category: QLHN / QLHN7 UL-file number: E232901
GTIN (EAN)	9003399104145
country of origin	AT
customs number	85366990
net weight	0.133 kg
packaging quantity	10
minimum order quantity	10

ETIM 9.0	EC001320
Amperage according to UL/CSA (for UL-version)	20 A
Number of poles	3
Clock hour position	5 h
Identification colour	Grey
Degree of protection (IP)	IP44
Connection system	Screwed terminal
Angle of plug	Straight
Cable entry	Gland nut
Material	Plastic
Contact material	CuZn
Surface treatment contacts	Untreated

a	5.24 inch
b	2.91 inch
K (cable Ø)	0.35-0.59 inch
SW	1.65 inch
wire flexible	16-12 AWG
contact screws	8.85 lbf-in
strain relief	44.3 lbf-in
dismantling length	1.97 inch
stripping length	0.39-0.47 inch
temperature resistance	-13 – 176 °F

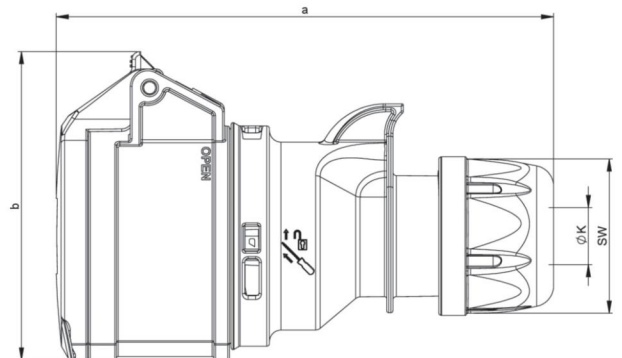

<https://www.pcelectric.at/shop/en/?func=detail&artnr=2139-5>