

article#	213-10v
article description	CEE-connector 16A 3p 10h IP44 SHARK
description long	CEE-connector 16A 3p 10h IP44/IP54 SHARK housing material: PA6 rated current: 16A number of poles: 3 (2P+PE) clock-position: 10h rated voltage/frequency: >50V~ / 100-300Hz contacts: brass nickel plated connection technology: screw terminals IP protection class: IP44/IP54
GTIN (EAN)	9003399151668
country of origin	AT
customs number	85366990
net weight	0.133 kg
packaging quantity	10
minimum order quantity	10

ETIM 9.0	EC001320
IEC-amperage	16 A
Number of poles	3
Voltage according to EN 60309-2	50-500 V (100-300 Hz) green
Clock hour position	10 h
Identification colour	Green
Degree of protection (IP)	IP44
Connection system	Screwed terminal
Angle of plug	Straight
Cable entry	Gland nut
Material	Plastic
Contact material	CuZn
Surface treatment contacts	Nickel-plated

a	133 mm
b	74 mm
K (cable Ø)	6-15 mm
SW	42 mm
wire flexible	1-2,5 mm ²
contact screws	100 Ncm
strain relief	500 Ncm
dismantling length	50 mm
stripping length	10-12 mm
ambient temperature	-25 – 40 °C
temperature resistance	-25 – 80 °C

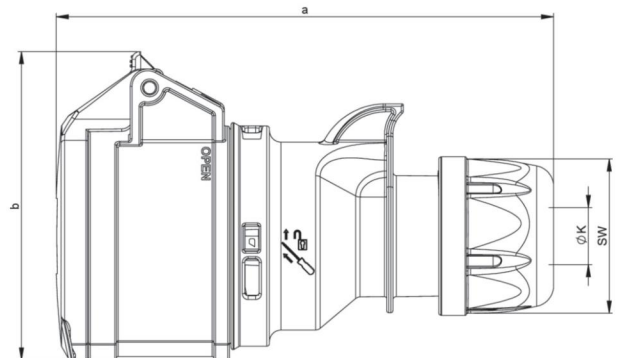

<https://www.pcelectric.at/shop/en/?func=detail&artnr=213-10v>