

article#	034-10
article description	CEE-plug 63A 4p 10h IP67 POWER TWIST
description long	CEE-plug 63A 4p 10h IP67 POWER TWIST housing material: PA6 rated current: 63A number of poles: 4 (3P+PE) clock-position: 10h rated voltage/frequency: >50V~ / 100-300Hz contacts: brass nickel plated, with pilot pin connection technology: frame terminals with screws IP protection class: IP66/IP67
GTIN (EAN)	9003399572630
country of origin	AT
customs number	85366990
net weight	0.617 kg
packaging quantity	2
minimum order quantity	2

ETIM 9.0	EC000140
IEC-amperage	63 A
Number of poles	4
Voltage according to EN 60309-2	50-500 V (100-300 Hz) green
Clock hour position	10 h
Identification colour	Green
RAL-number	7046
Degree of protection (IP)	IP67
Connection system	Screwed terminal
Cable entry	Gland nut
Angle of plug	Straight
Material	Plastic
Contact material	CuZn
Surface treatment contacts	Nickel-plated

a	250 mm
b	115 mm
K (cable Ø)	14,5-36 mm
SW	61 mm
wire flexible	6-16 mm ²
contact screws	200 Ncm
connecting screws	200 Ncm
strain relief	1500 Ncm
dismantling length	100 mm
stripping length	15-18 mm
ambient temperature	-25 – 40 °C
temperature resistance	-25 – 80 °C

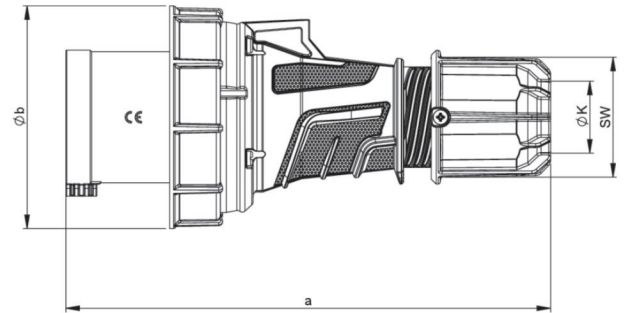

<https://www.pcelectric.at/shop/en/?func=detail&artnr=034-10>