

article#	02492-6v
article description	CEE-plug 30A 3P4W 6h IP67 UL
description long	CEE-plug 30A 3P4W 6h IP67 UL (PCE430P6Wv) housing material: PA6 rated current: 32A/30A number of poles: 3P4W (4p) clock position: 6h rated voltage: 380Vac contacts: brass nickel plated connection technology: screw terminals IP protection class: IP67 according to UL1682 und IEC/EN 60309-2 (SERIE II) UL-product category: QLHN / QLHN7 UL-file number: E232901
country of origin	AT
customs number	85366990
packaging quantity	10
minimum order quantity	10

ETIM 9.0	EC000140
IEC-amperage	32 A
Amperage according to UL/CSA (for UL-version)	30 A
Number of poles	4
Clock hour position	6 h
Identification colour	Red
Degree of protection (IP)	IP67
Connection system	Screwed terminal
Cable entry	Gland nut
Angle of plug	Straight
Material	Plastic
Contact material	CuZn
Surface treatment contacts	Nickel-plated

a	5.91 inch
b	3.66 inch
K (cable Ø)	0.52-0.76 inch
SW	1.97 inch
wire flexible	14-10 AWG
contact screws	9.74 lbf-in
strain relief	62.0 lbf-in
dismantling length	1.97 inch
stripping length	0.47-0.55 inch
temperature resistance	-13 – 176 °F

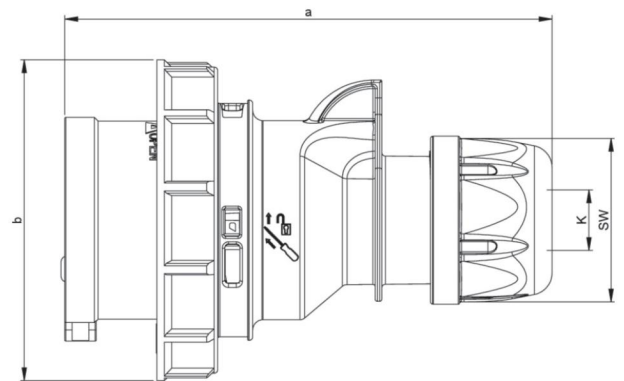

<https://www.pcelectric.at/shop/en/?func=detail&artnr=02492-6v>