

article#	01592-7
article description	CEE-plug 20A 4P5W 7h IP67 UL
description long	CEE-plug 20A 4P5W 7h IP67 UL (PCE520P7W) housing material: PA6 rated current: 20A number of poles: 4P5W (5p) clock position: 7h rated voltage: 277/480Vac contacts: brass connection technology: screw terminals IP protection class: IP67 according to UL1682 UL-product category: QLHN / QLHN7 UL-file number: E232901
GTIN (EAN)	9003399444913
country of origin	AT
customs number	85366990
net weight	0.183 kg
packaging quantity	10
minimum order quantity	10

ETIM 9.0	EC000140
Amperage according to UL/CSA (for UL-version)	20 A
Number of poles	5
Clock hour position	7 h
Identification colour	Red
Degree of protection (IP)	IP67
Connection system	Screwed terminal
Cable entry	Gland nut
Angle of plug	Straight
Material	Plastic
Contact material	CuZn
Surface treatment contacts	Untreated

a	5.28 inch
b	3.43 inch
K (cable Ø)	0.35-0.63 inch
SW	1.65 inch
wire flexible	16-12 AWG
contact screws	8.85 lbf-in
strain relief	44.3 lbf-in
dismantling length	1.97 inch
stripping length	0.39-0.47 inch
temperature resistance	-13 – 176 °F

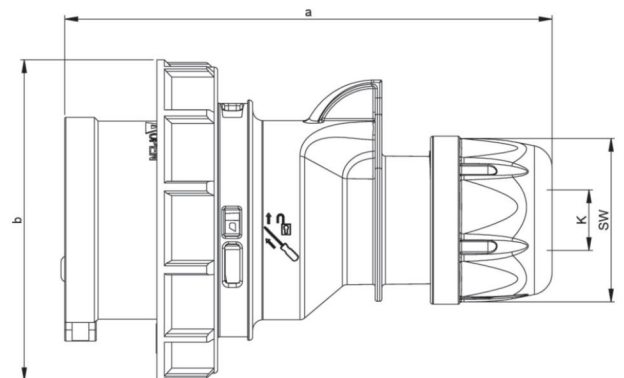

<https://www.pcelectric.at/shop/en/?func=detail&artnr=01592-7>