

article#	01492-5v
article description	CEE-plug 20A 3P4W 5h IP67 UL
description long	CEE-plug 20A 3P4W 5h IP67 UL (PCE420P5Wv) housing material: PA6 rated current: 20A number of poles: 3P4W (4p) clock position: 5h rated voltage: 600Vac contacts: brass nickel plated connection technology: screw terminals IP protection class: IP67 according to UL1682 UL-product category: QLHN / QLHN7 UL-file number: E232901
GTIN (EAN)	9003399847103
country of origin	AT
customs number	85366990
net weight	0.154 kg
packaging quantity	10
minimum order quantity	10

ETIM 9.0	EC000140
Amperage according to UL/CSA (for UL-version)	20 A
Number of poles	4
Clock hour position	5 h
Identification colour	Black
Degree of protection (IP)	IP67
Connection system	Screwed terminal
Cable entry	Gland nut
Angle of plug	Straight
Material	Plastic
Contact material	CuZn
Surface treatment contacts	Nickel-plated

a	5.04 inch
b	3.11 inch
K (cable Ø)	0.35-0.59 inch
SW	1.65 inch
wire flexible	16-12 AWG
contact screws	8.85 lbf-in
strain relief	44.3 lbf-in
dismantling length	1.97 inch
stripping length	0.39-0.47 inch
temperature resistance	-13 – 176 °F

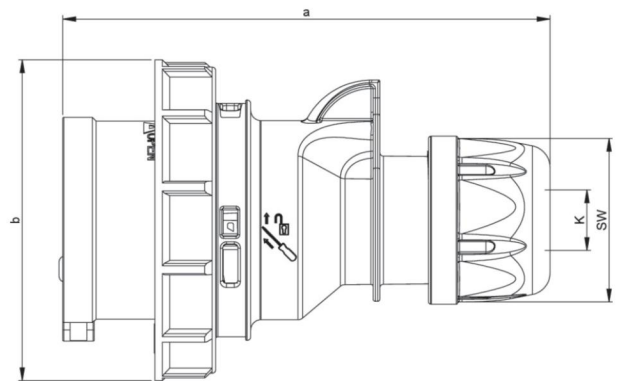

<https://www.pcelectric.at/shop/en/?func=detail&artnr=01492-5v>